

Falun A / 170 / 21

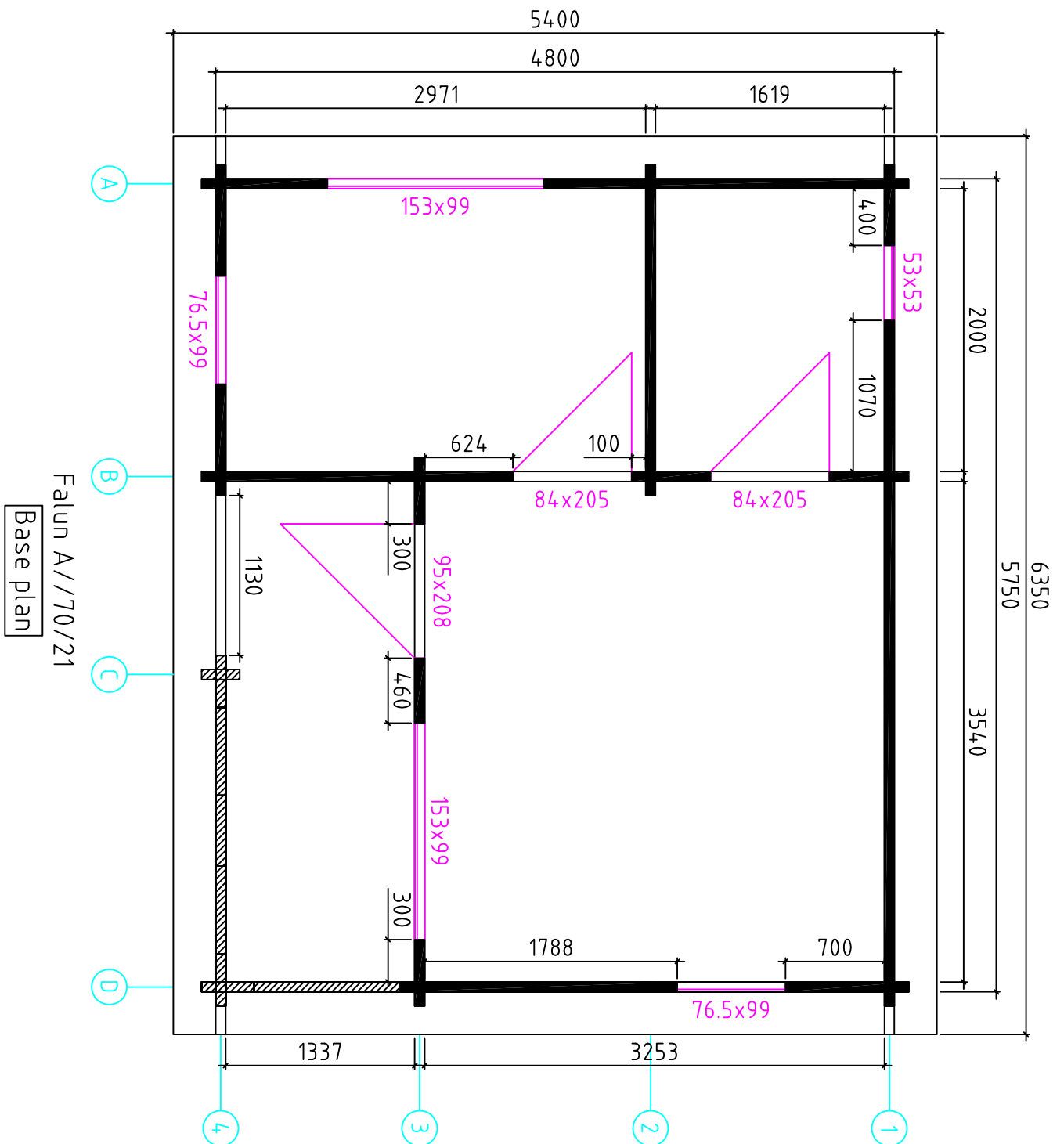

Screws
6x130

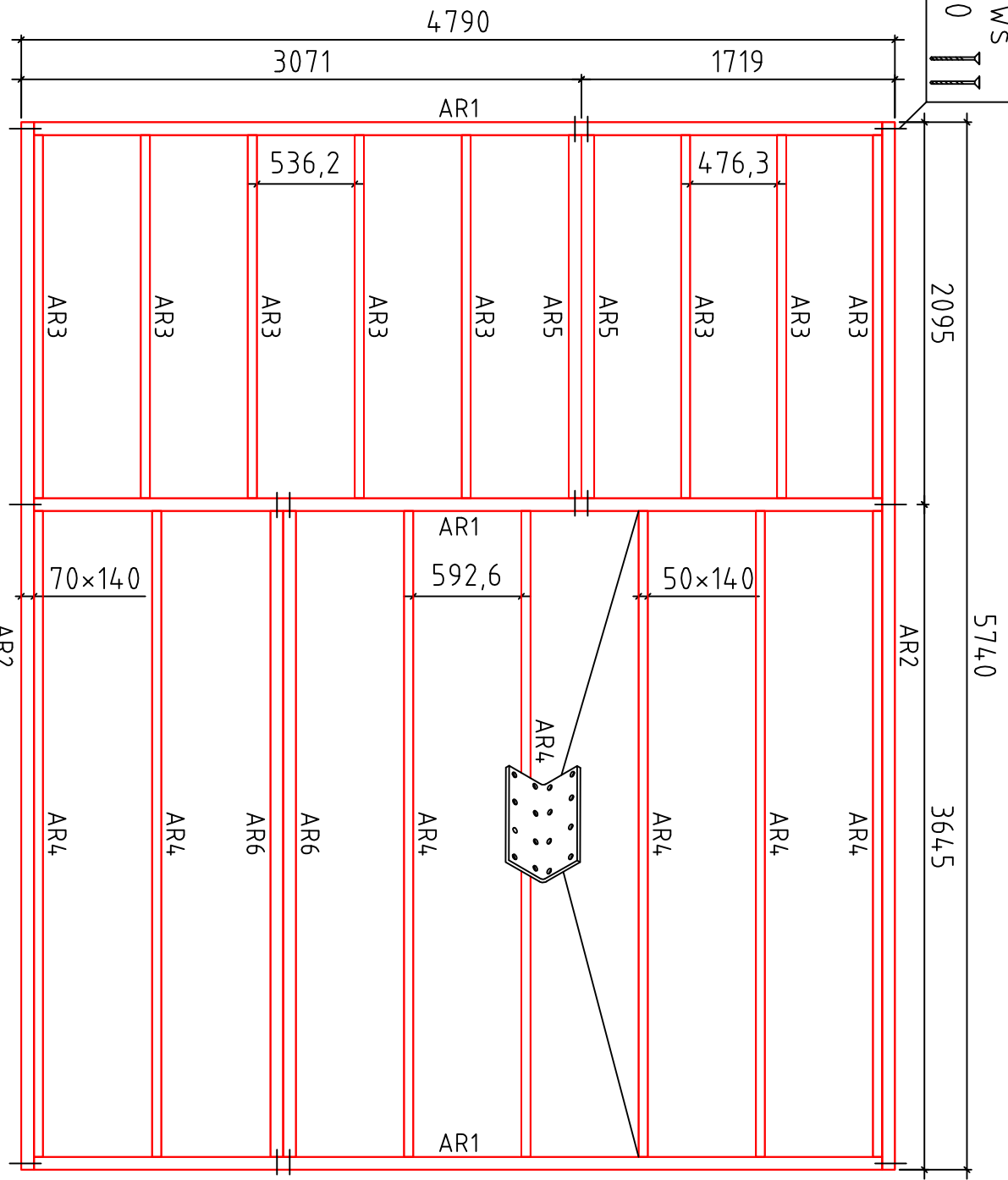

Falun A//70/21
Foundation

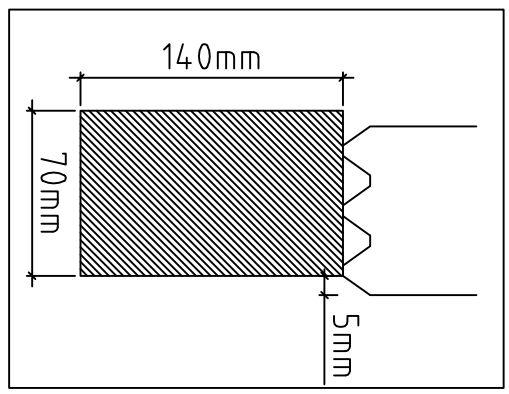

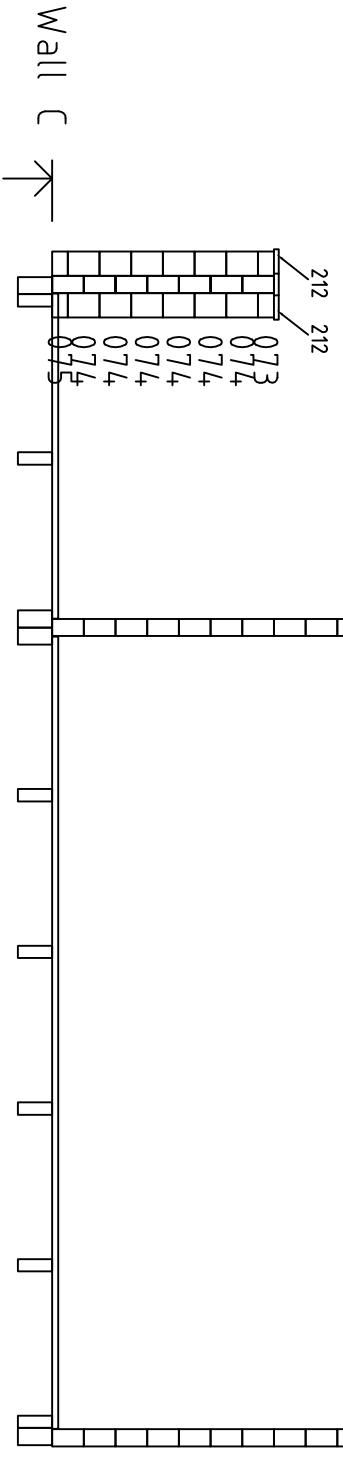
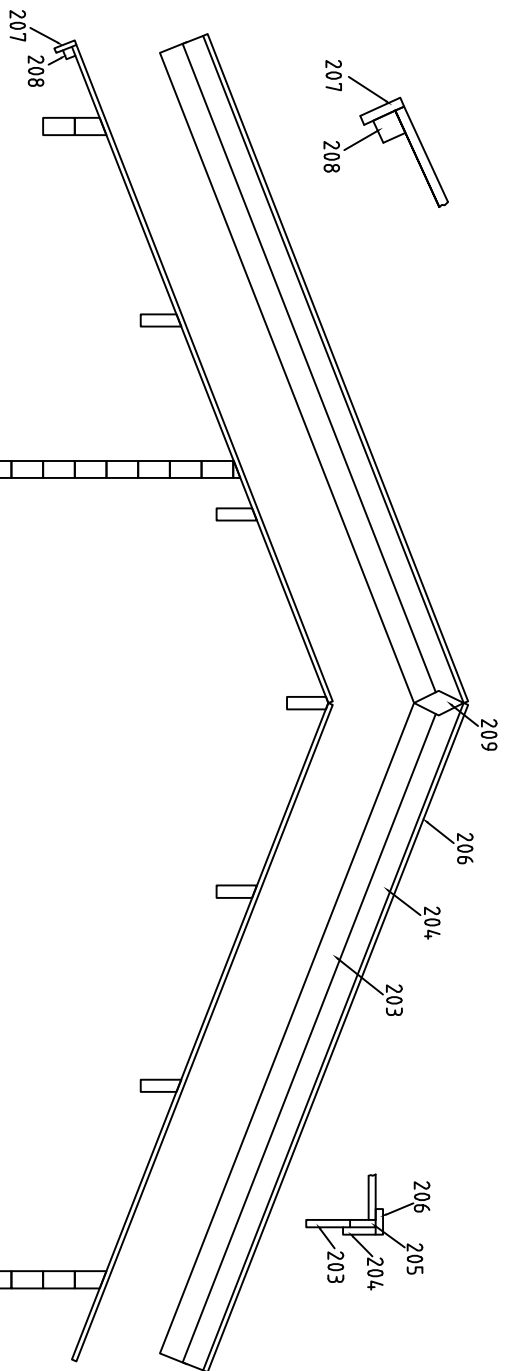

Falun A//70/21

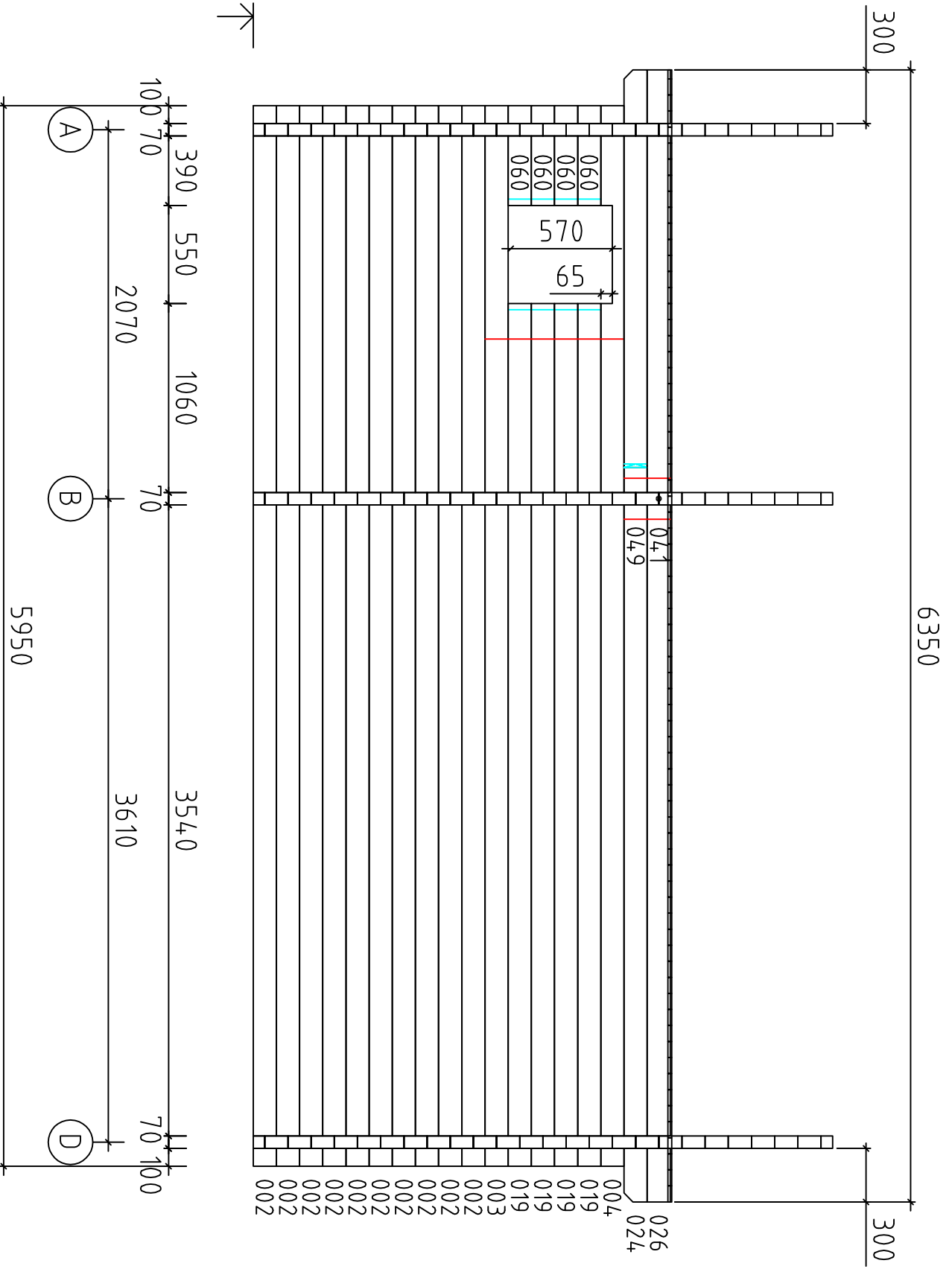

6350

300

300

041
049

026
024

060
060
060
060

570

65

002
002
002
002
002
002
002
002
002
002
002
002
002
002
003
019
019
019
004

Wall 1 ↗

100
70

390

550

1060

70

3540

3610

70
100

2070

(A)

(B)

(D)



5950

Falun A//70/21

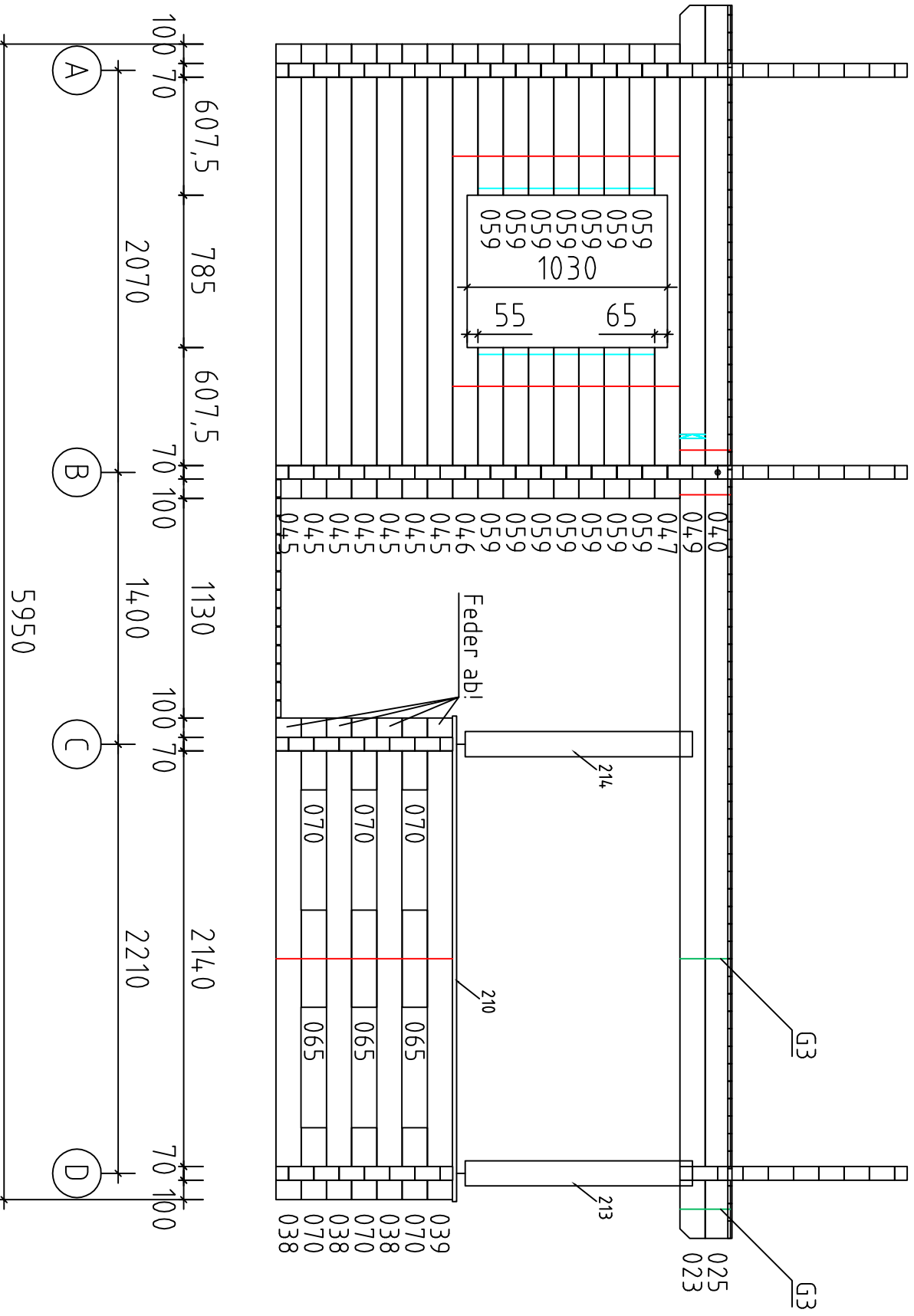



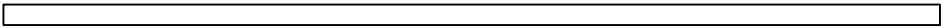
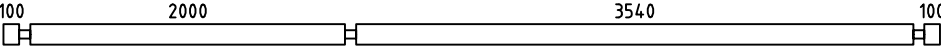
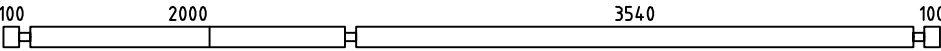
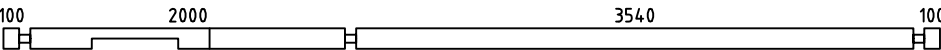
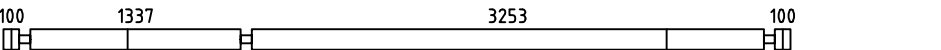
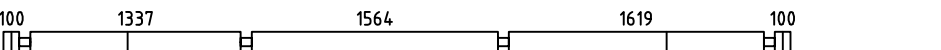
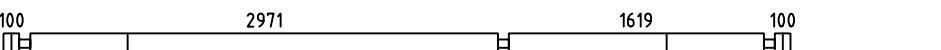
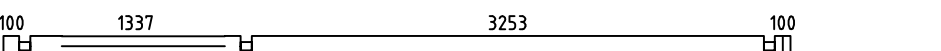
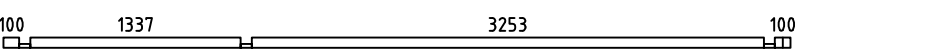
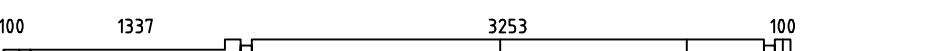
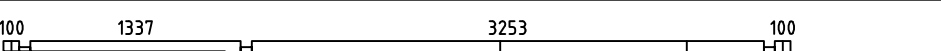
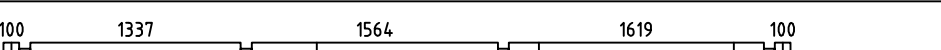
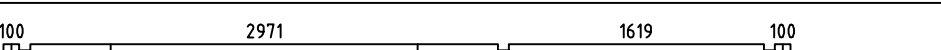
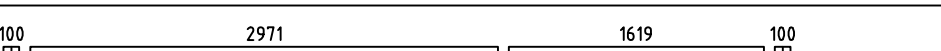
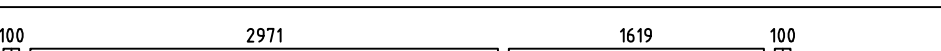

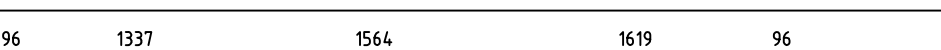
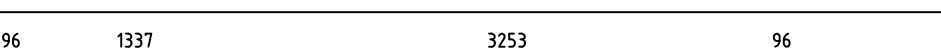
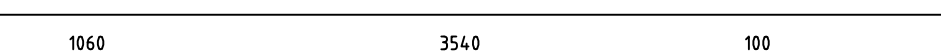
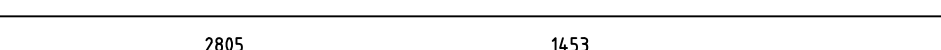
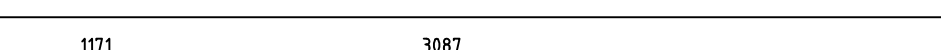
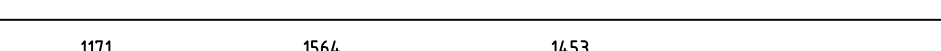
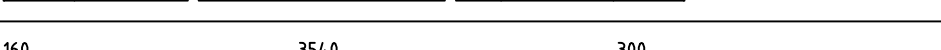
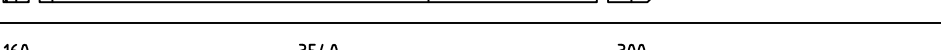
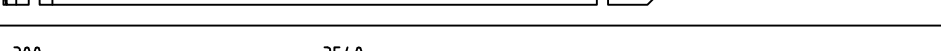



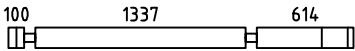
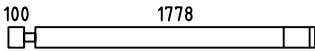
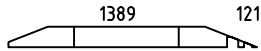
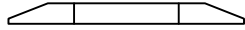
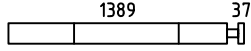
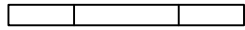
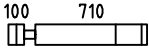
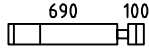
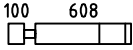
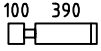
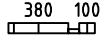
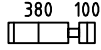
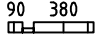
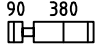

Wall 4 













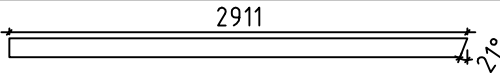
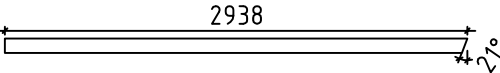
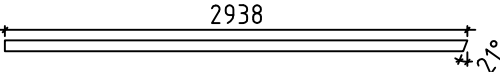

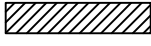

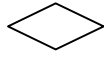
Falun A//70/21

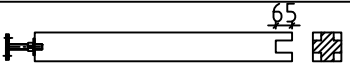
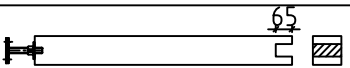
Pos	Falun A//70/21	ST	F (mm)	L (mm)
Reserv		2	70x130	5950
002		10	70x130	5950
003		1	70x130	5950
004		1	70x130	5950
005		1	70x130	5000
006		1	70x130	5000
007		1	70x130	5000
008		3	70x130	5000
009		1	70x65	5000
010		1	70x130	5000
011		1	70x130	5000
012		1	70x130	5000
013		2	70x130	5000
014		6	70x130	5000
015		1	70x65	5000
016		1	70x130	4993
017		1	70x130	4993
018		1	70x130	4993
019		4	70x130	4840
020		1	70x130	4327
021		1	70x130	4327
022		1	70x130	4327
023		1	70x130	4140
024		1	70x130	4140
025		1	70x130	3945

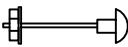
Pos	Falun A//70/21	ST	F (mm)	L (mm)
026		1	70x130	3945
027		1	70x30	3880
028		5	70x130	3880
029		1	70x130	3880
030		3	70x130	3593
031		1	70x130	3088
032		1	70x130	3088
033		1	70x130	3088
034		1	70x130	2996
035		1	70x130	2996
036		1	70x130	2996
037		8	70x130	2570
038		3	70x130	2480
039		1	70x129	2480
040		1	70x130	2405
041		1	70x130	2405
042		7	70x130	2400
043		1	70x130	2400
044		1	70x130	2400
045		29	70x130	2340
046		1	70x130	2340
047		1	70x130	2340
048		1	70x130	2340
049		2	70x130	2230
050		1	70x65	2191

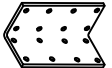
Pos	Falun A//70/21	ST	F (mm)	L (mm)
051		15	70x130	2191
052		8	70x130	1948
053		2	70x130	1580
054		1	70x130	1497
055		2	70x130	1497
056		1	70x130	1497
057		8	70x130	880
058		8	70x130	860
059		14	70x130	778
060		4	70x130	560
061		1	70x65	550
062		15	70x130	550
063		1	70x65	540
064		15	70x130	540
065		3	70x130	500
066		6	70x130	474
067		7	70x130	460
068		16	70x130	410
069		7	70x130	390
070		9	70x130	370
071		4	70x130	367
072		2	70x130	367
073		1	70x65	270
074		6	70x130	270
075		1	70x65	270

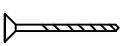
Pos	Falun A//70/21		ST	F (mm)	L (mm)
076			6	70x92	236
077			6	70x55	141
079			3	70x25	50
AR2	Foundation beam 		Impr. 2	70x140	5740
AR1	Foundation beam 		Impr. 3	70x140	4650
AR6	Foundation beam 		Impr. 2	70x140	3540
AR5	Foundation beam 		Impr. 2	70x140	1990
AR4	Foundation beam 		Impr. 7	50x140	3540
AR3	Foundation beam 		Impr. 8	50x140	1990
PR6			2	70x190	4130
PR2			2	70x190	4130
PR4			1	70x190	4130
PR5			2	70x190	2590
PR3			1	70x190	2590
PR1			2	70x190	2590
199	Floor boards		41	90x26	3250
			23	90x26	2967
			23	90x26	1615
200	Terrace boards		Impr. 13	90x26	1405
			Impr. 26	90x26	1334
201	Roof boards		142	90x20	2890
202	Baseboard			20x40	35lfm

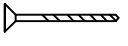
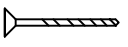
Pos	Falun A//70/21	ST	F (mm)	L (mm)
203	Fascia board 	4	20x120	2911
204	Fascia board 	4	20x90	2938
205	Fascia board 	4	20x70	2938
206	Gable edge board 	4	20x70	2938
207	Eave edging 	4	20x90	3175
208	Eave edging slat 	4	40x40	3175
209	Diamond 	2		
210	Handrail 	1	20x90	2500
211		1	20x90	1227
212		3	20x90	100
213	Post 	1	130x130	1150
214	Post 	1	130x130	1150
215	Dowel 	210		
216	Hitblock	2	70x130	ca400
217	Bolts for purlins 	20	M12	80
G1	Threaded rod 12 	5		2315
G2		1		235
G3		2		285
KMPL.	Angle brackets 	30	60x60x60	
	Screws for angle brackets 4x40 	300		
	Screws for foundation 6x130 	30		
	Screws for boards 3,5x50 	1200		
	Screws for terrace boards 4x55 	120		
	Screws for posts 5x80 	20		
	Screws for gables 6x130 	50		

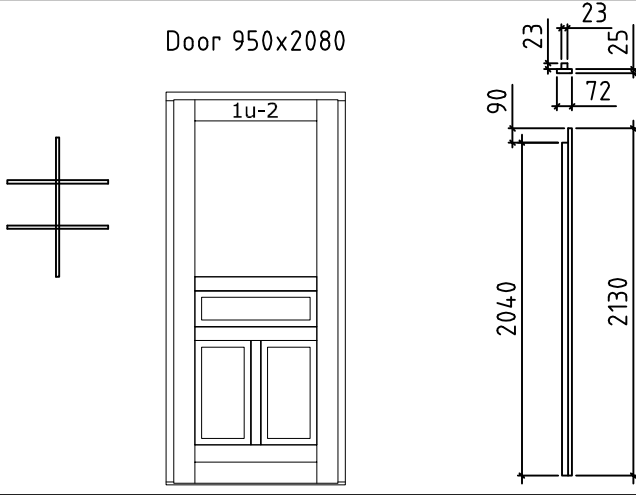
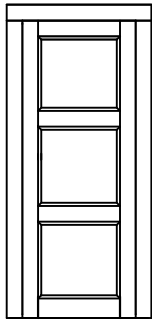
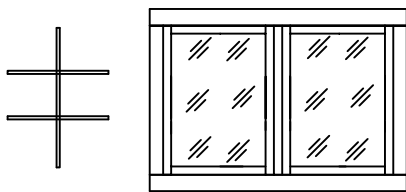
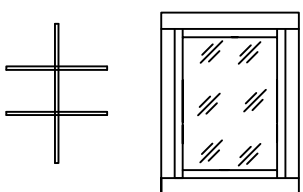
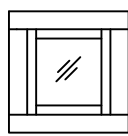
Pos	Falun A//70/21	ST	F (mm)	L (mm)
T1	<p>Door 950x2080</p> 	1L		
T2	<p>Door 840x2050</p>  <p>Fixing slat 23x23x1970=4st.</p>	2L		
F1	<p>Window 1530x990</p>  <p>Fixing slat 23x23x980=2st. Fixing slat 23x23x850=2st.</p>	2		
F2	<p>Window 765x990</p>  <p>Fixing slat 23x23x980=2st. Fixing slat 23x23x850=2st.</p>		1L+1R	
F3	<p>Window 530x530</p>  <p>Fixing slat 23x23x460=2st.</p>	1L		
Kood	Materjal	File	trükkäranäpi.dwg	Leht 5/5

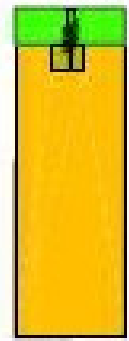
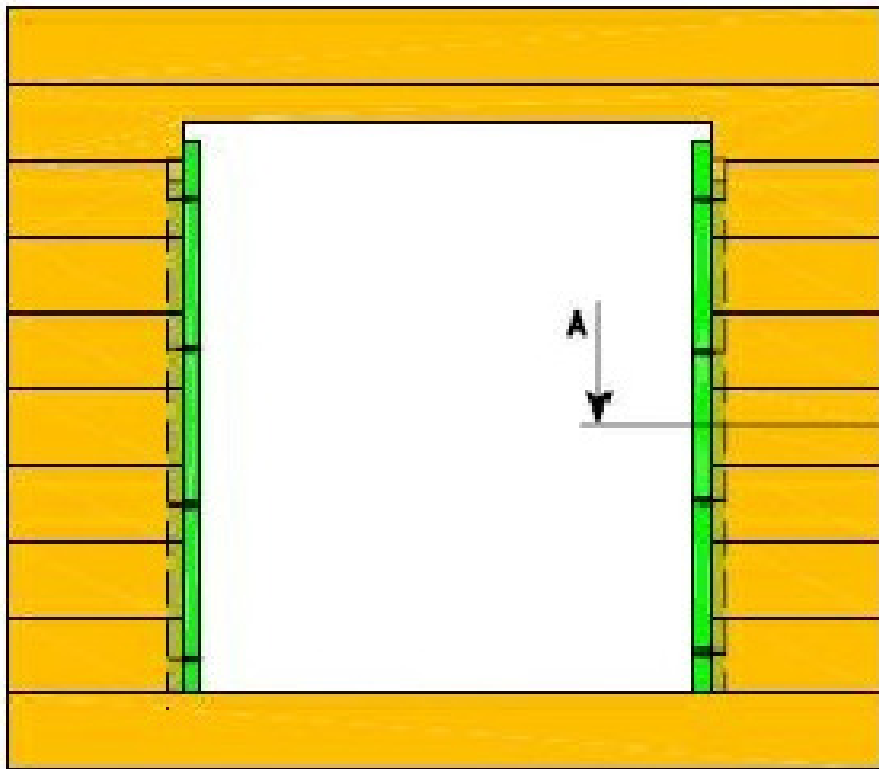

A-A

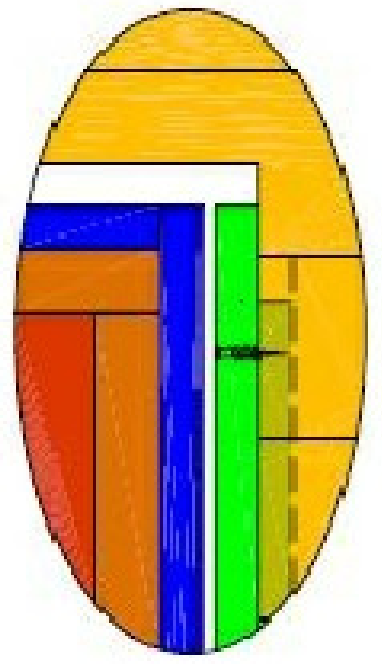

Isolation wool

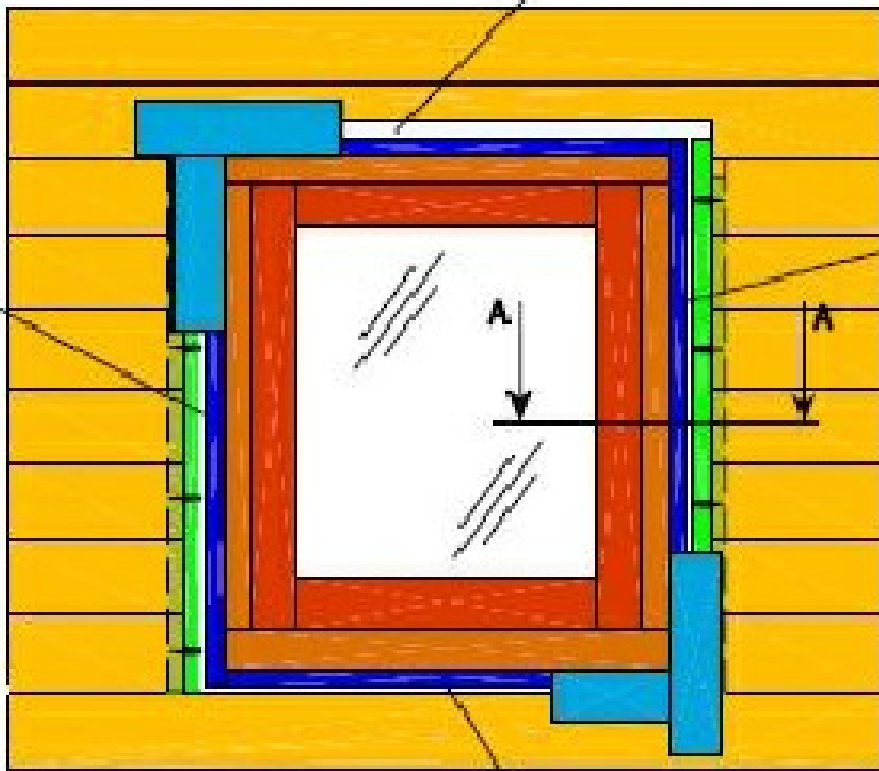

Foam

Foam

Foam

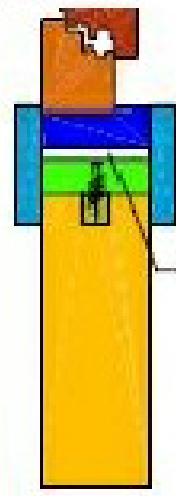

Foam

A-A